

# SV—SMART VIDEO ENTRY INSTALLATION AND SET UP MANUAL

## SET UP WITHOUT LOCKING OPTIONS

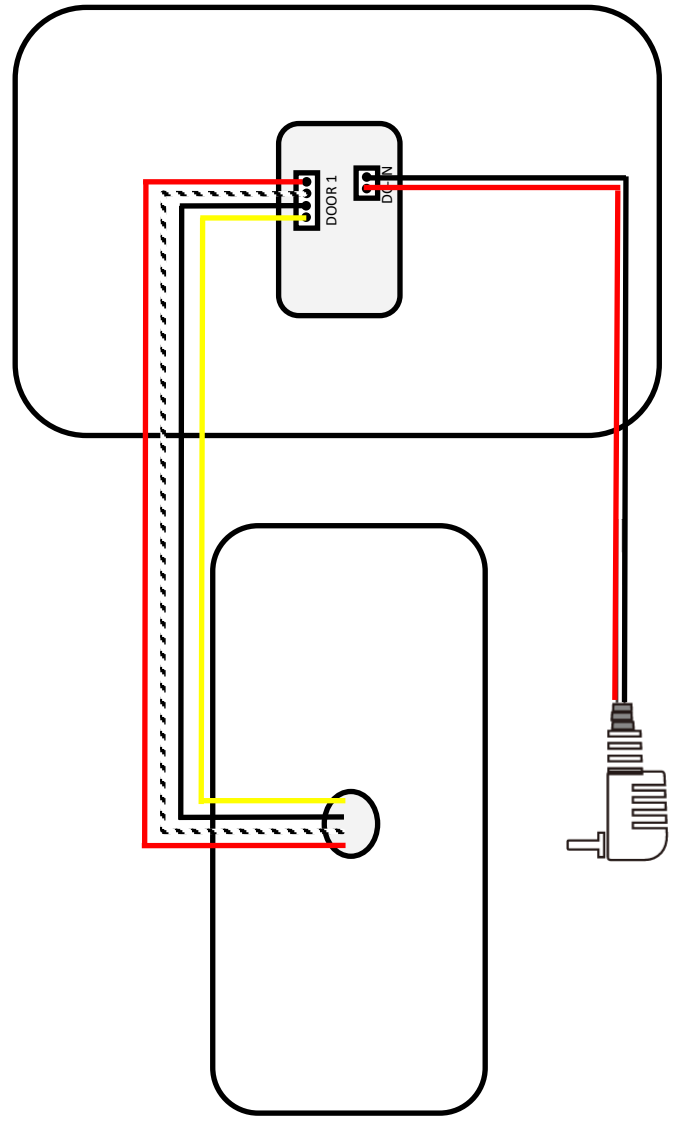



# SET UP WITHOUT LOCKING OPTIONS

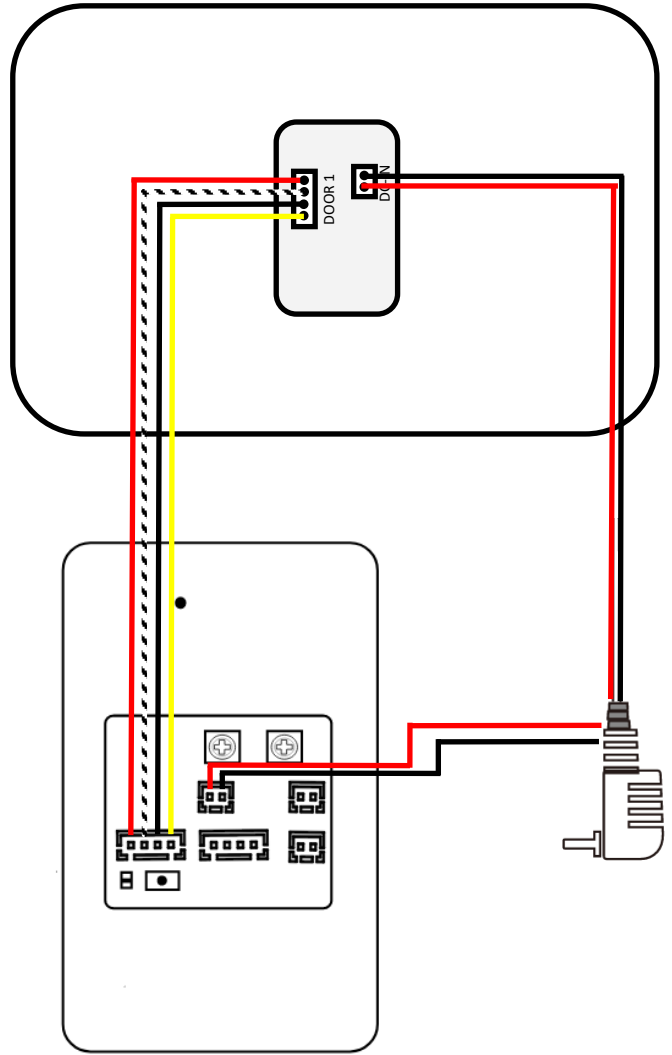

# SET UP WITH LOCKING OPTIONS

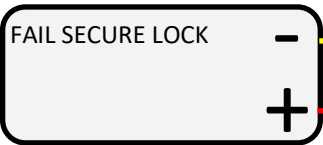
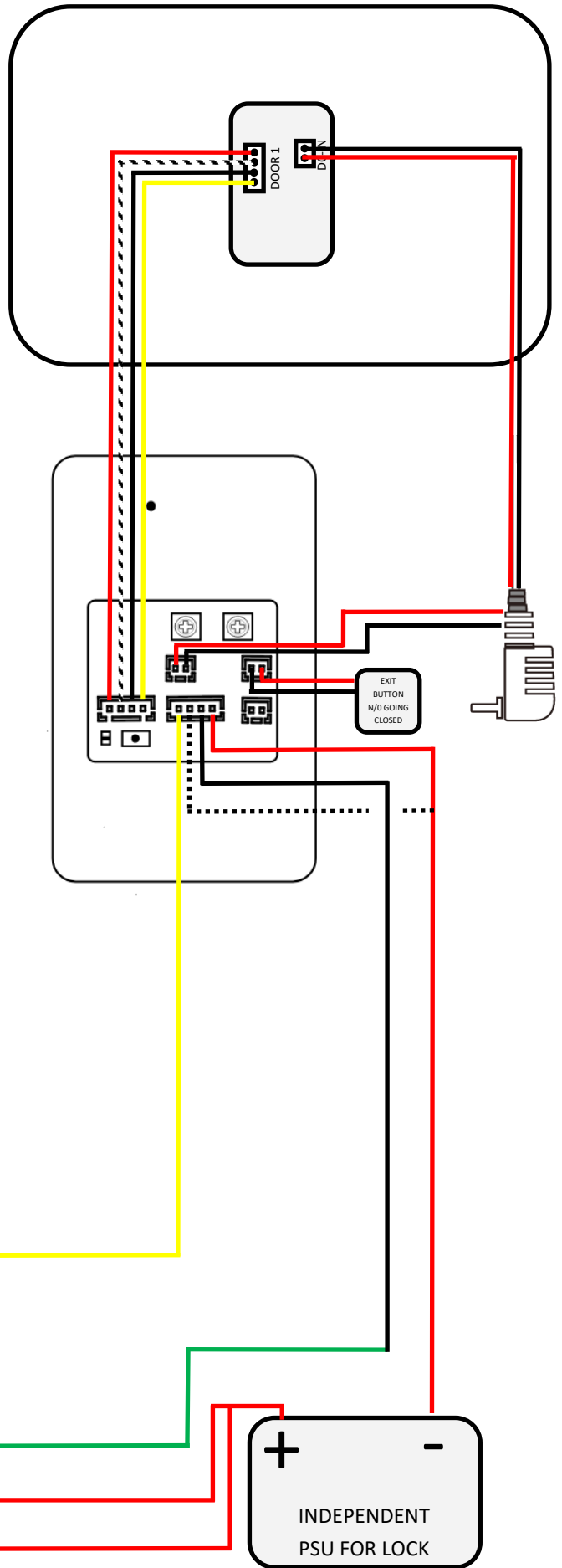

# Getting Started

Once your video kit is wired up correctly and power is applied then please follow the following steps,

## STEP 1

Tap anywhere on the home screen to unlock

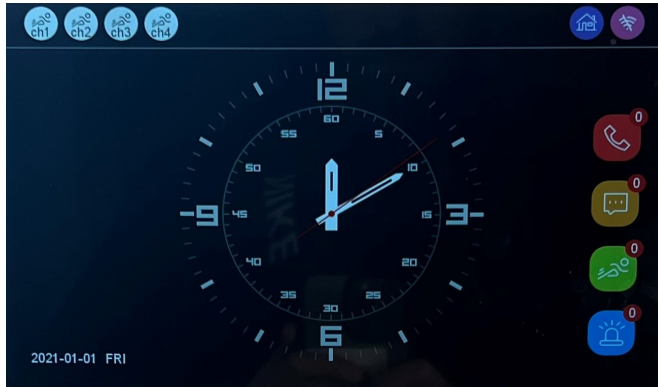

## STEP 2

Click on settings

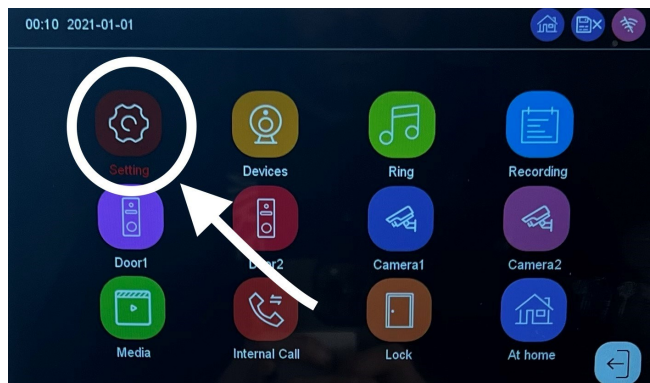

## STEP 3

Click on network

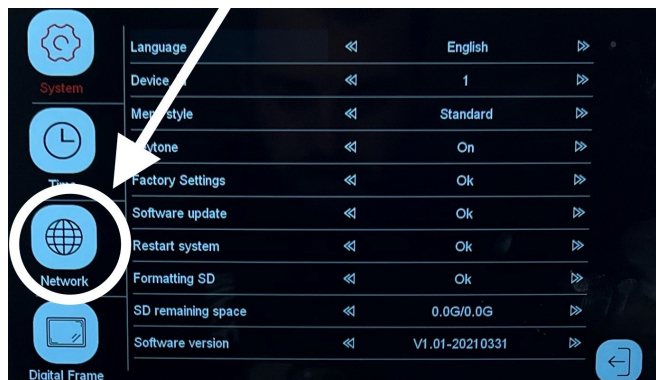



## STEP 4

Tap on the arrow to change the net pairing mode to 'AP MODE'

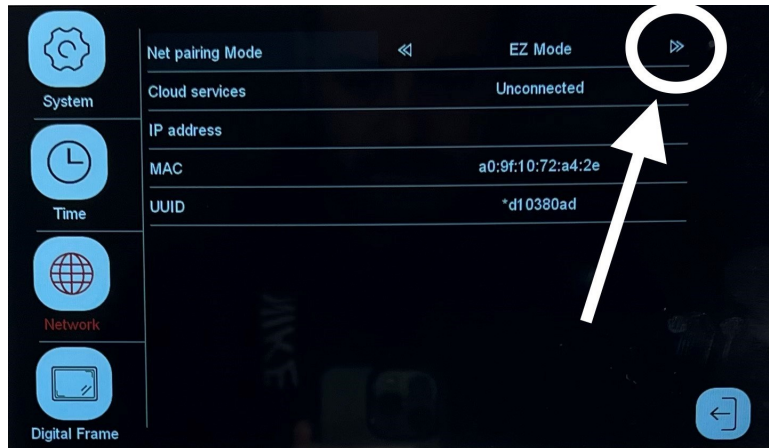

## STEP 5

Tap on the back button at the bottom right hand corner and then click 'Ok'. This will reset the system into AP mode.

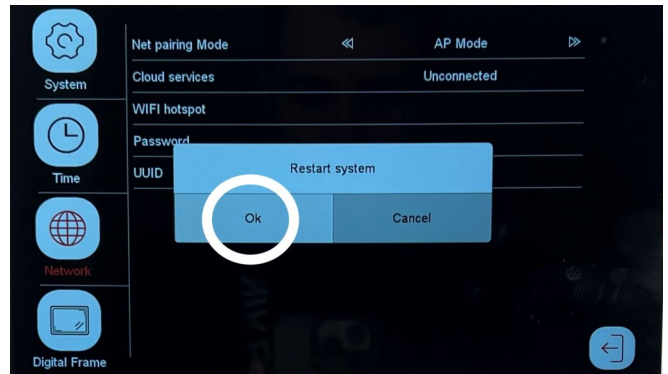
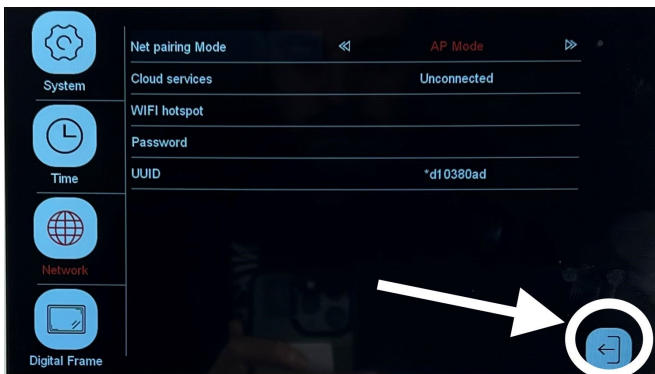

## STEP 6

When the monitor has reset itself, go into settings > network and you will see that it has automatically input itself into AP MODE.

In the square white box is the information you need to connect to your phone. 'WIFI hotspot and the password. The password is always defaulted to 12345678 and cannot be changed.

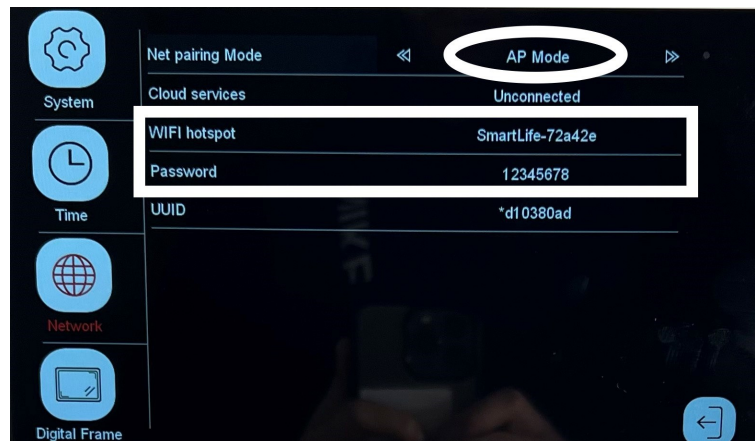

# STEP 7

Open the AMALOCK app on your mobile phone. On the home page click on the '+' sign at the top of the screen and then click on add device.

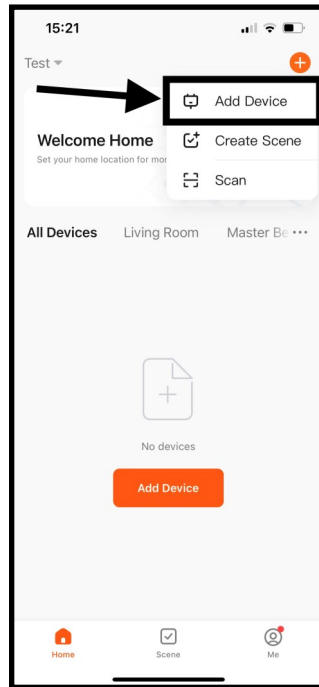
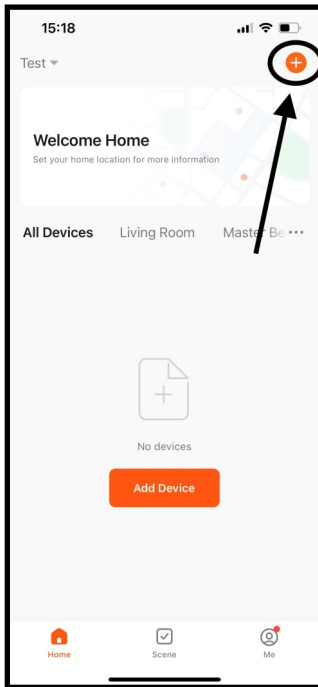

# STEP 8

Down the left side click 'Camera & Lock' Then click on 'Smart Camera (Wi-Fi)'

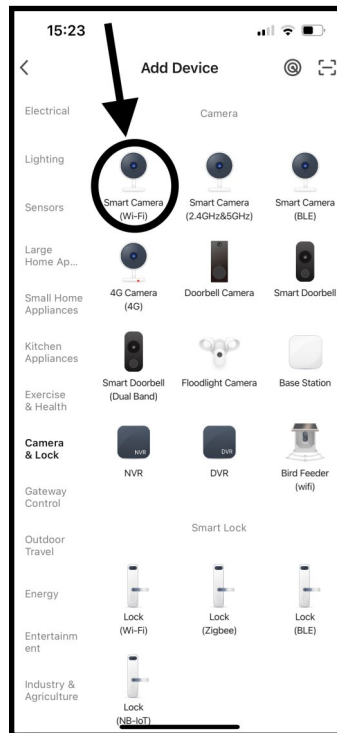
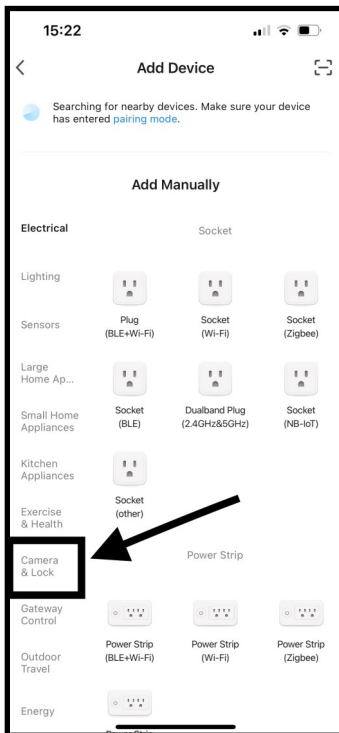

# STEP 9

At the top right hand corner you will see it says 'QR Code for Camera' Click on that and change it to 'AP MODE'

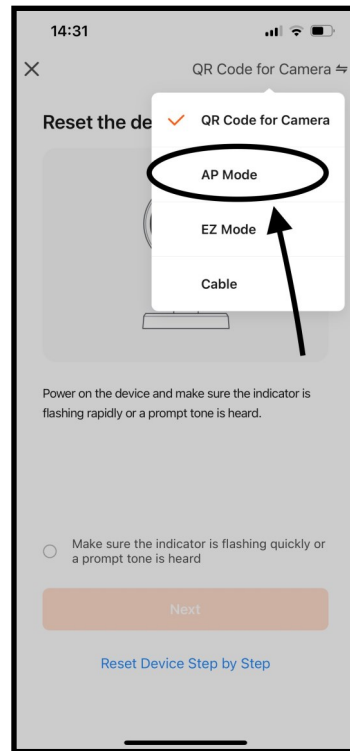
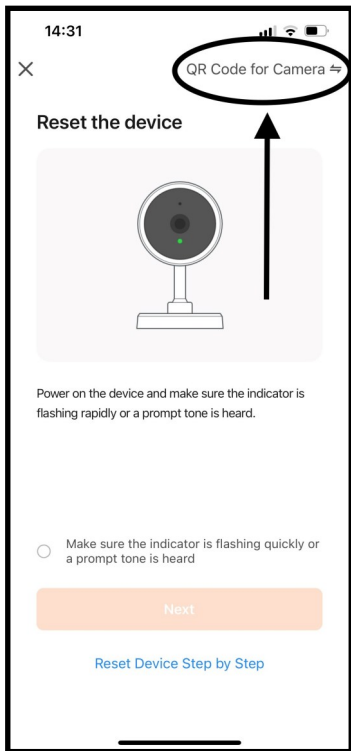

# STEP 10

You can now see it has changed to 'AP MODE' in the red circle. Click on 'Next Step' and then click 'Next' in the orange box.

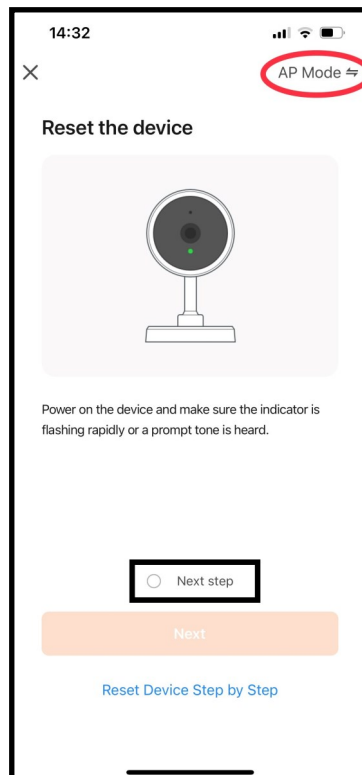



## STEP 11

Input your WIFI name and then your WIFI password then click next

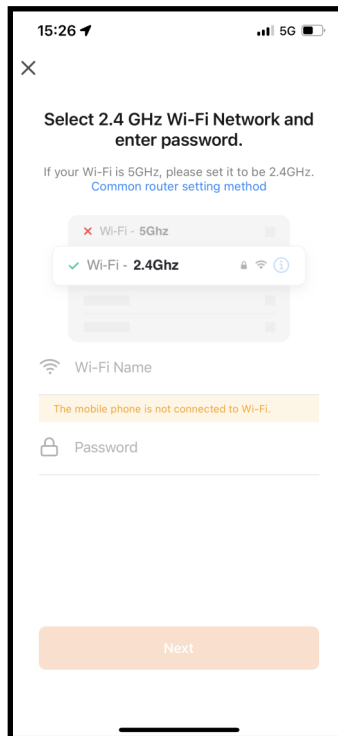

## STEP 12

Click on 'Go to Connect. This will take you to your phone settings on your mobile phone.

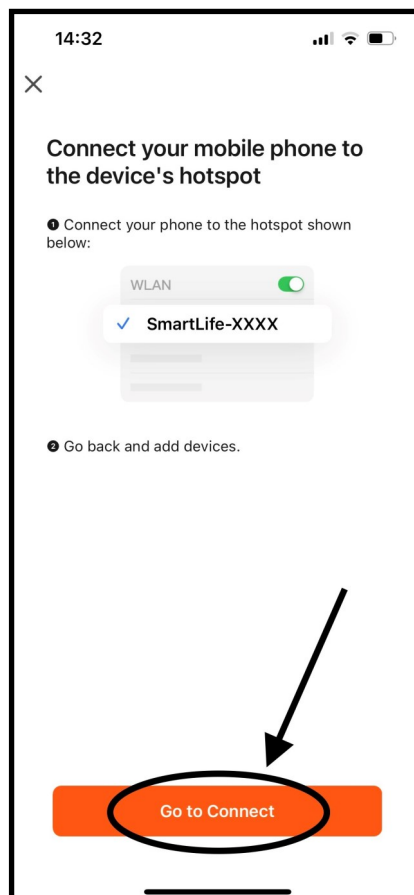

## STEP 13

Click on the WIFI in settings.



## STEP 14

Find the WIFI that starts with 'Smartlife'. Make sure that it is the same WIFI name as the one on the monitor. As you can see on both pictures they are the same.

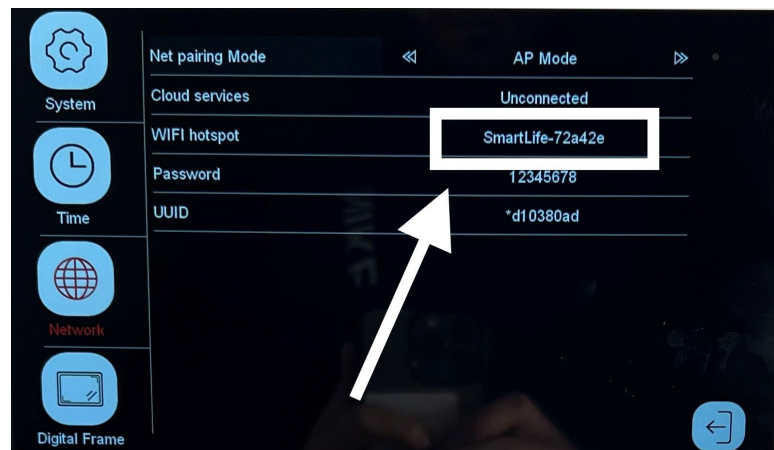
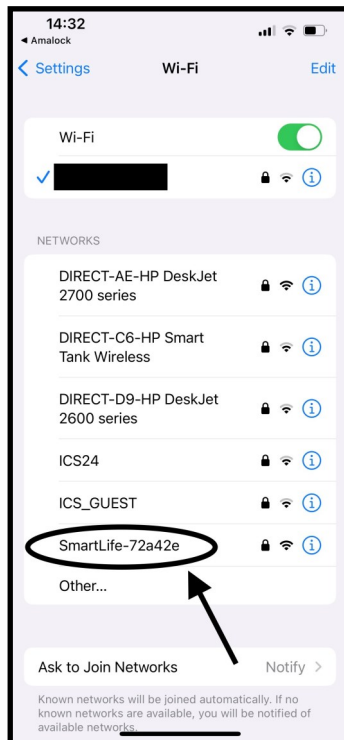

# STEP 15

On the monitor you should see the password under the WIFI hotspot. Type that into the password on your phone then click join and wait for that to connect. The password is 12345678

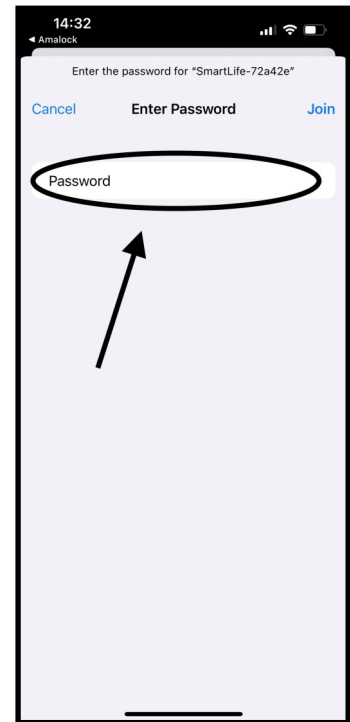
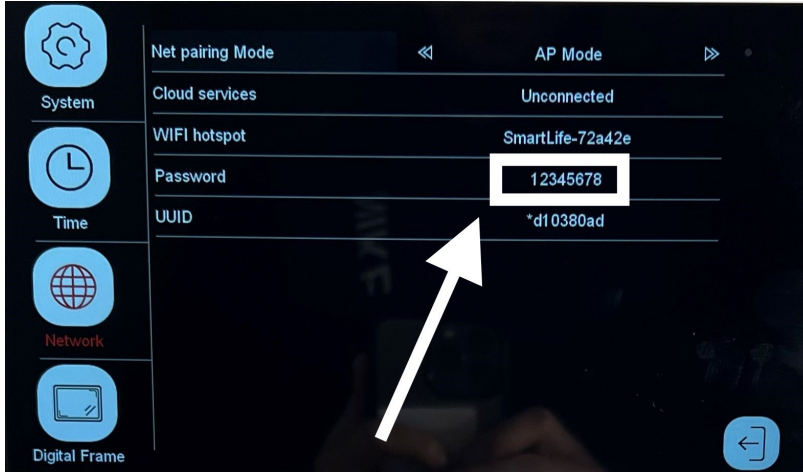

When it is connected you should see a blue tick next to the Smartlife WIFI. When that is complete go back onto the AMALOCK app.

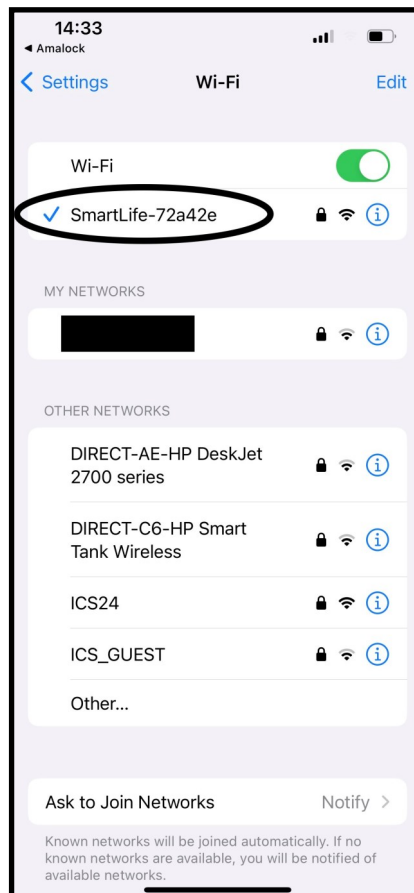

## STEP 16

When you open up the AMALOCK app it should take you to this page where it starts to connect to the monitor

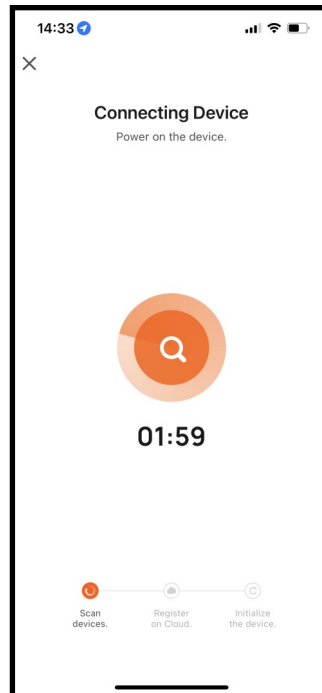

## STEP 17

When it has connected you can edit the name of the device to what ever you want by clicking the symbol in the black circle. Then click done to finish.

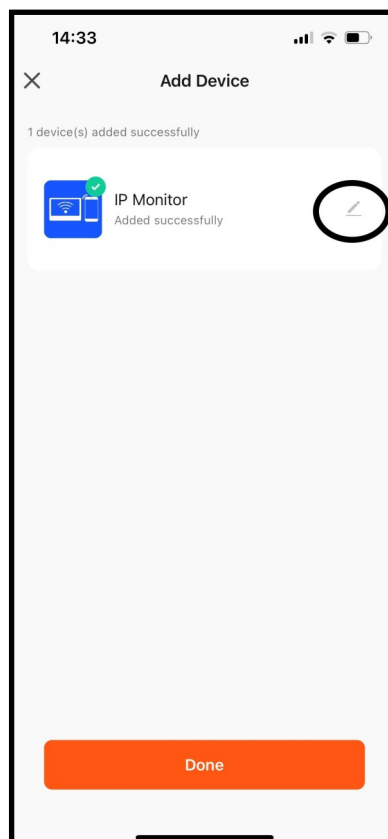

# SV—KEYPAD PROGRAMMING INSTRUCTIONS

## MASTER CODE

The master code is used to put the keypad into programme mode, it will **not** open the door.

The default mastercode is **123456**

## CHANGING THE MASTER CODE

1.  
**123456** then press **#** ( you should hear 2 long beeps and the ring around the push button should start flashing)

2.  
**0** then **#** ( you should hear 1 long beep and the flashing ring should flash faster)

3.  
Enter your new 6 digit master code **XXXXXX** followed by **#**

Then wait for 30 seconds and the keypad will return to standby mode.

( You will hear 2 short beeps and the flashing ring will stop flashing)

## SETTING A NEW PASSCODE

A passcode is used to open the door / gate.

You can programme up to 200 different codes using the 200 storage locations available **000 – 199**.

It is important to remember which slot a passcode is stored as when you need to delete a passcode it is done via its slot.

1.  
**123456** then press **#** ( you should hear 2 long beeps and the ring around the push button should start flashing)

2.  
**1** then **#** ( you should hear 1 long beep and the flashing ring should flash faster)

3.  
Enter the first location slot **000** then press **#**. ( A single long beep should be heard.)

4.  
At this point enter your 6 digit passcode **XXXXXX** (this is the code used to open the door/gate) then **#**.

( A single long beep should be heard.)

Then wait for 30 seconds and the keypad will return to standby mode.

( You will hear 2 short beeps and the flashing ring will stop flashing)

# DELETE A PASSCODE

1.

**123456** then press **#** ( you should hear 2 long beeps and the ring around the push button should start flashing)

2.

**2** then **#** ( you should hear 1 long beep and the flashing ring should flash faster)

3.

Enter the location slot of the passcode that needs to be deleted **XXX** then press **#**. ( A single long beep should be heard.)

Then wait for 30 seconds and the keypad will return to standby mode.

( You will hear 2 short beeps and the flashing ring will stop flashing)

# ADDING TOKENS OR CARDS

A token or card is used to open the door / gate.

You can programme up to 200 different cards or tokens using the 200 storage locations available **000 – 199**.

It is important to remember which slot a card or token is stored as when you need to delete a passcode it is done via its slot.

You cannot store a card or token in a slot that already has a passcode in it.

1.

**123456** then press **#** ( you should hear 2 long beeps and the ring around the push button should start flashing)

2.

**3** then **#** ( you should hear 1 long beep and the flashing ring should flash faster)

3.

Enter the first location slot **000** then press **#**. ( A single long beep should be heard.)

4.

At this point **show your card or token** to the keypad, it will beep to signify it has recognized the card or token, then press **#**.

( A single long beep should be heard.)

Then wait for 30 seconds and the keypad will return to standby mode.

( You will hear 2 short beeps and the flashing ring will stop flashing)



## DELETE A CARD OR TOKEN

1.  
**123456** then press **#** ( you should hear 2 long beeps and the ring around the push button should start flashing)

2.  
**4** then **#** ( you should hear 1 long beep and the flashing ring should flash faster)

3.  
Enter the location slot of the card or token that needs to be deleted **XXX** then press **#**. ( A single long beep should be heard.)  
Then wait for 30 seconds and the keypad will return to standby mode.  
( You will hear 2 short beeps and the flashing ring will stop flashing)

## ADDING FINGERPRINTS

You can programme up to 200 different fingerprints using the 200 storage locations available **000 – 199**.

It is important to remember which slot a fingerprint is stored as when you need to delete a passcode it is done via its slot.  
You cannot store a fingerprint in a slot that already has a passcode or token in it.

1.  
**123456** then press **#** ( you should hear 2 long beeps and the ring around the push button should start flashing)

2.  
**5** then **#** ( you should hear 1 long beep and the flashing ring should flash faster)

3.  
Enter the first location slot **000** then press **#**. ( A single long beep should be heard.)

4.  
At this point **place your finger on the fingerprint reader** and the keypad will beep to signify that it has stored your fingerprint then press **#**.  
( A single long beep should be heard.)  
Then wait for 30 seconds and the keypad will return to standby mode.  
( You will hear 2 short beeps and the flashing ring will stop flashing)

# DELETE A FINGERPRINT

1.  
**123456** then press **#** ( you should hear 2 long beeps and the ring around the push button should start flashing)

2.  
**6** then **#** ( you should hear 1 long beep and the flashing ring should flash faster)

3.  
Enter the location slot of the fingerprint that needs to be deleted **XXX** then press **#**. ( A single long beep should be heard.)  
Then wait for 30 seconds and the keypad will return to standby mode.  
( You will hear 2 short beeps and the flashing ring will stop flashing)

# KEYPAD LIGHT SETTINGS

The keypad can be set up with three different light settings,

1. Keypad lights always off
2. Keypad lights always on
3. Keypad lights off when in standby but on when being used. ( factory default)

## **LIGHTS ALWAYS OFF**

**123456** then **#**

**7** then **#**

**00** then **#**

Then wait for 30 seconds and the keypad will return to standby mode.

## **LIGHTS ALWAYS ON**

**123456** then **#**

**7** then **#**

**01** then **#**

Then wait for 30 seconds and the keypad will return to standby mode.

## **LIGHTS OFF IN STANDBY—ON IN USE**

**123456** then **#**

**7** then **#**

**02** then **#**

Then wait for 30 seconds and the keypad will return to standby mode.

## How to add groups and how to change members to administrator

On The home page, select 'ME' at the bottom right hand corner

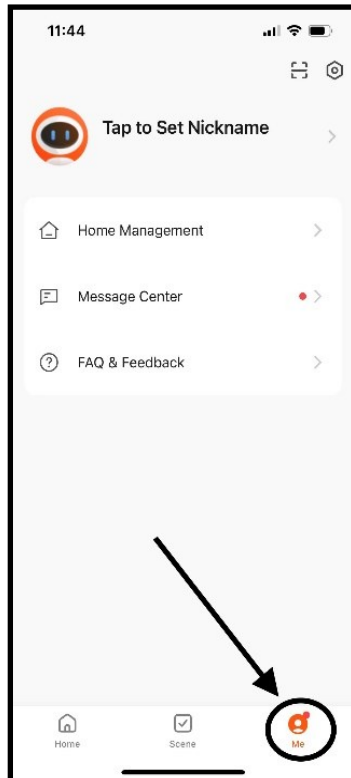

Tap on 'Home Management'

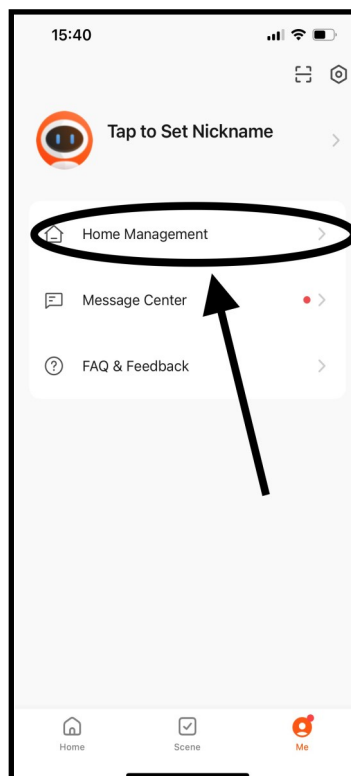

Click on 'create a home'

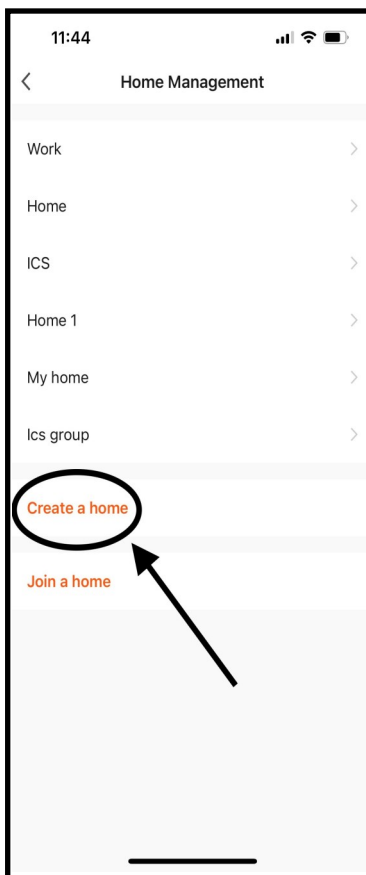

Set a name for the group in 'Home Name' section

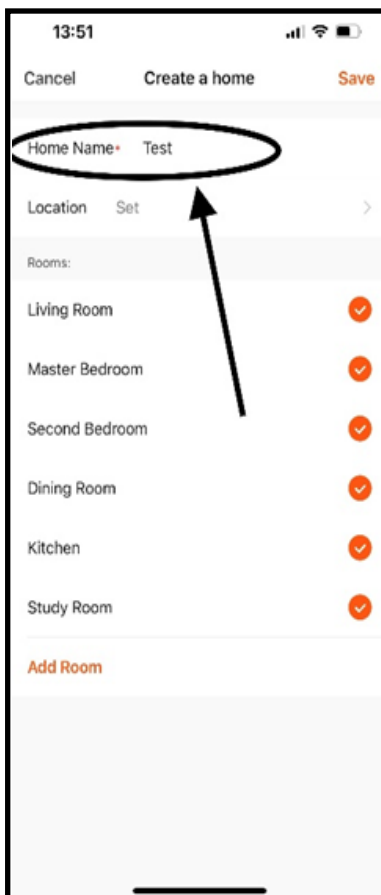

Unselect the rooms you do not need, or you can add a room by clicking on 'Add Room'

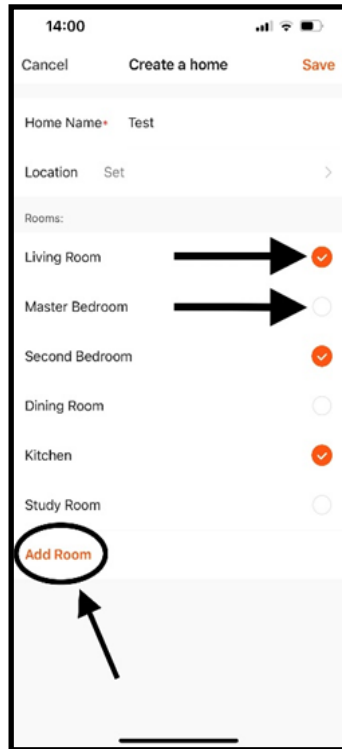

After clicking save, click on the group you have created

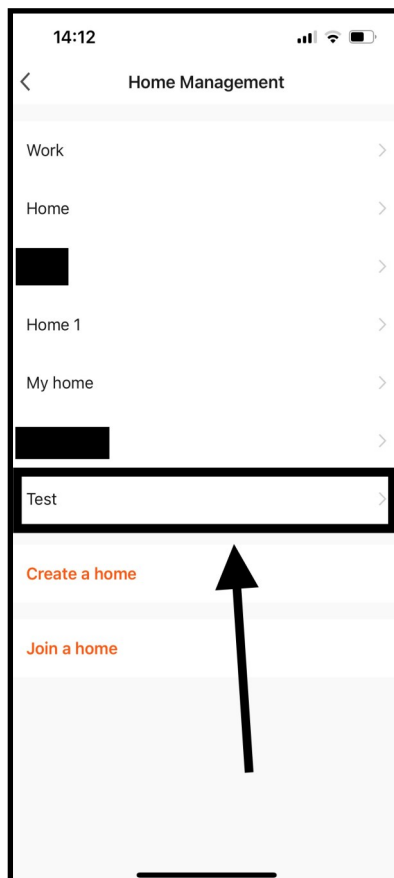

Tap on 'Add Member' to add a member to the group

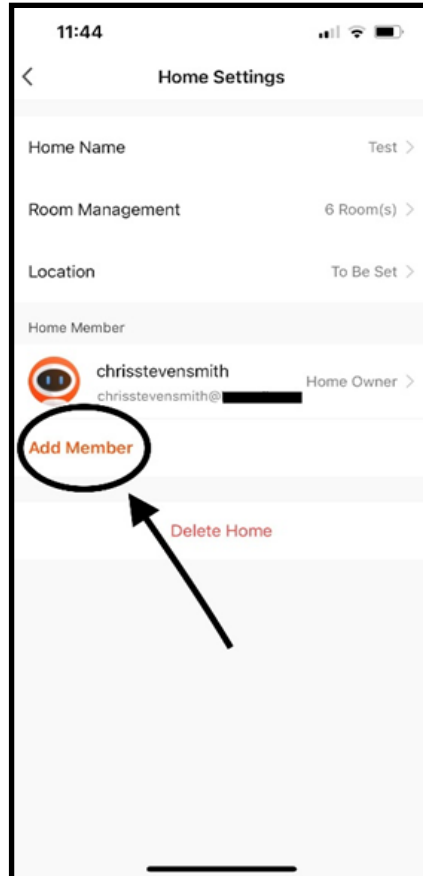

**Before you add a member please make sure they have an account with amalock.**

Tap on 'App Account'

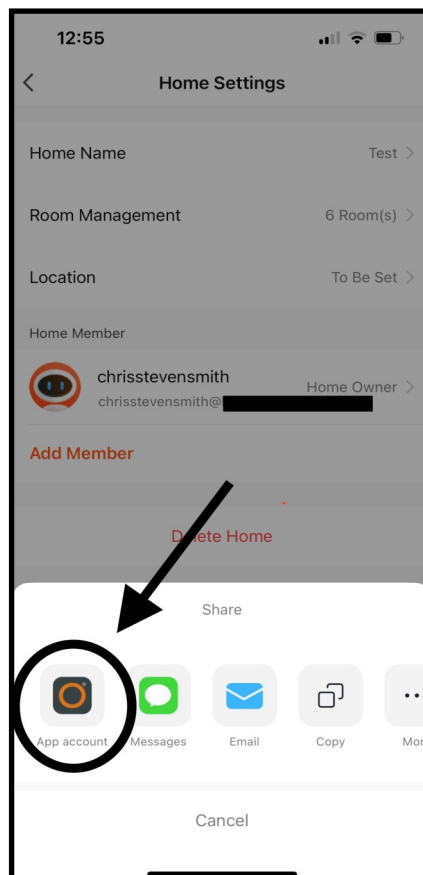



Input the name and the email address of the person you want to add to the group.  
Example to the right. The email is the same email they signed up with to the amalock app.

To change the members permission, click on 'Family Role' box

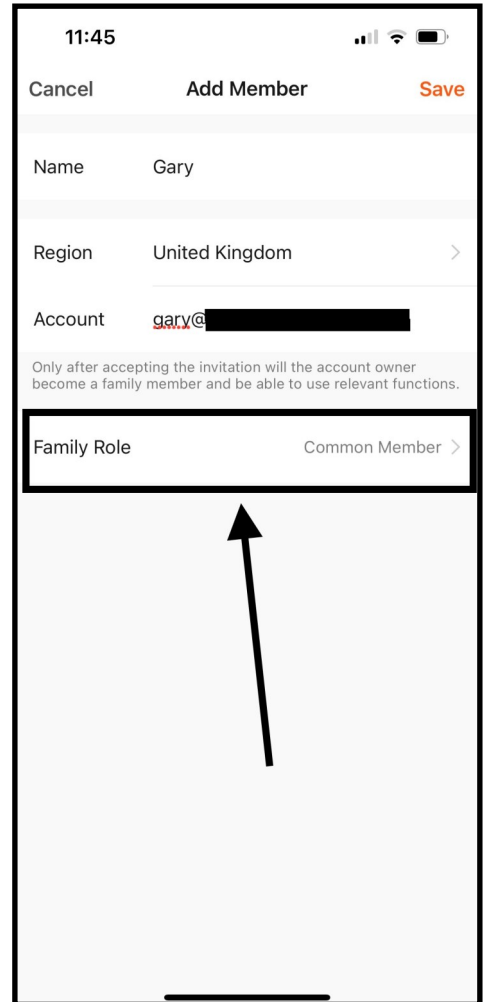

Click on 'Administrator'

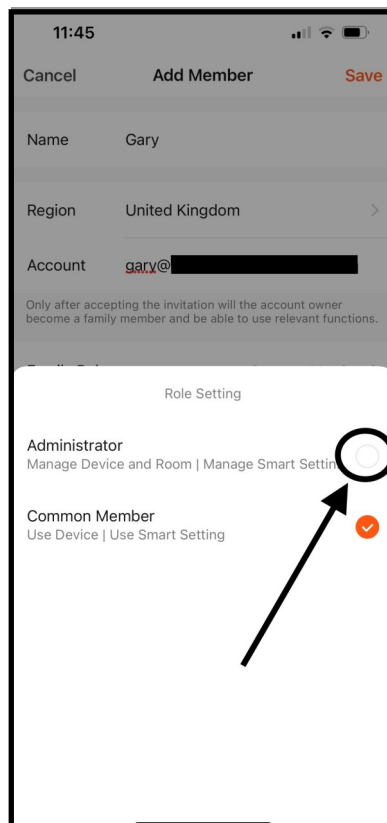

You should now have set the new member as an Administrator

11:45

Cancel Add Member Save

Name Gary

Region United Kingdom >

Account gary@[redacted]

Only after accepting the invitation will the account owner become a family member and be able to use relevant functions.

Family Role Administrator >

Finally click save at the top right hand side of the screen.